

# TACT SWITCH: 6 X 6 TYPE 60-2000

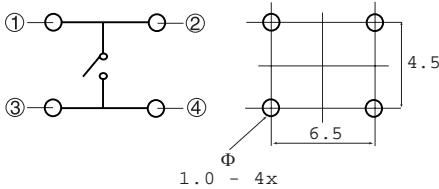

**STANDARD**

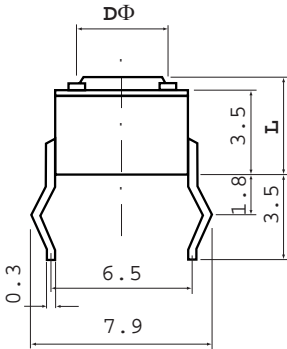
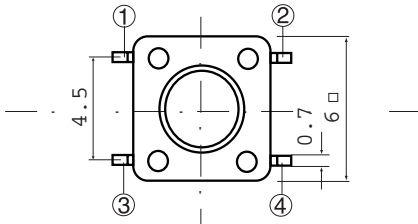
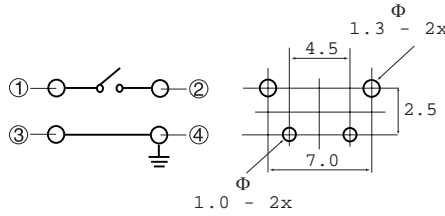
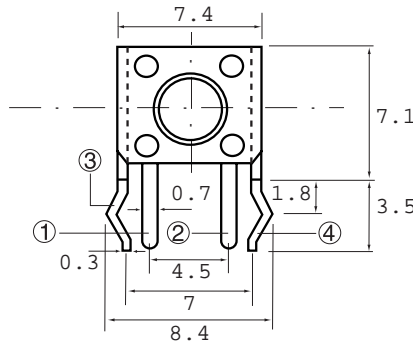
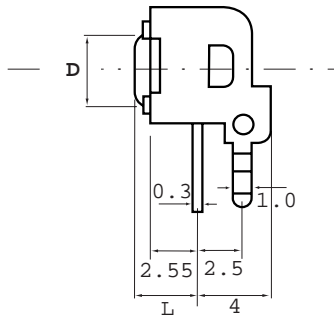

**VERTICAL**

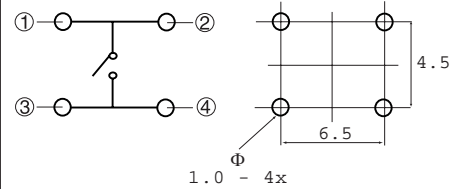
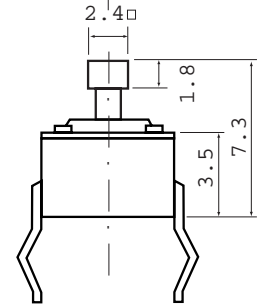
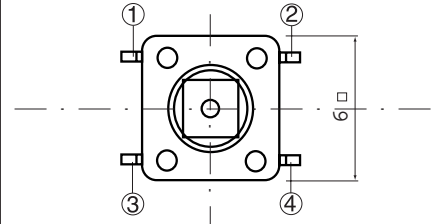

**SQUARE**

OPERATING		SWITCH CODE	SWITCH CODE	SWITCH CODE
FORCE (GRAMS)	LIFE (CYCLES)			
100	100,000	60-2S4L	60-2V4L	60-2S4T
130	100,000	60-2S1L	60-2V1L	60-2S1T
160	100,000	60-2S2L	60-2V2L	60-2S2T
250	100,000	60-2S3L	60-2V3L	60-2S3T

**HIGH LIFE UPTO 1,000,000 ALSO AVAILABLE**

X KNOB CODE	KNOB L mm		Dφ mm
	STANDARD & EARTHING	VERTICAL	
A	4.3	3.15	3.5
B	5.0	3.85	3.5
C	7.0	5.85	3.3
D	8.0	6.85	3.3
E	9.5	8.35	3.0

X KNOB CODE	KNOB L mm		Dφ mm
	STANDARD & EARTHING	VERTICAL	
F	12.5	11.35	3.0
G	13.5	12.35	3.0
H	17.0	15.85	3.0
T	SQUARE STEM 2.4 x 2.4		

## SPECIFICATIONS:

CONTACT	: METAL CONTACT
RATING	: 50 mA x 12 V DC
CONTACT RESISTANCE	: 100 mΩ MAX
PROOF VOLTAGE	: 250 V AC FOR 1 MIN
INSULATION RESISTANCE	: 100 MΩ MIN/100 V DC
RESISTANCE TO SOLDERING HEAT	: HAND 270 ± 10°C - 3 SEC MAX AUTO 255 ± 5°C - 5 SEC MAX



**PRODUCT: TACT SWITCH 6 x 6 TYPE: 60-2000**

**DIMENSIONS: MM TOLERANCE: ± 0.2 MM**

**CHECKED BY: \_\_\_\_\_ DATE: \_\_\_\_\_**

**APPROVED BY: \_\_\_\_\_ DATE: \_\_\_\_\_**



**Pran Electronics Pvt. Ltd.**

52 G.I.D.C. Makarpura

Vadodara 390 010. INDIA.

Phone: 0265 263 2916, 263 5920.

Fax: 0265 263 5918.

Email: info@pranelectronics.com